

Equitable Labellings of Cycles

JERZY WOJCIECHOWSKI

Department of Mathematics, West Virginia University,
Morgantown, WV 26506, USA

and

Department of Pure Mathematics and Mathematical Statistics,
University of Cambridge, 16 Mill Lane, Cambridge, CB2 1SB, England

E-mail:

UN020243@WVNVMS.WVNET.EDU

JERZY@MATH.WVU.WVNET.EDU

December 15, 1990

Abstract. Every labelling of the vertices of a graph with distinct natural numbers induces a natural labelling of its edges: the label of an edge (x, y) is the absolute value of the difference of the labels of x and y . By analogy with graceful labellings, we say that a labelling of the vertices of a graph of order n is minimally k -equitable if the vertices are labelled with $1, 2, \dots, n$ and in the induced labelling of its edges every label either occurs exactly k times or does not occur at all. Bloom [3] posed the following question: Is the condition that k is a proper divisor of n sufficient for the cycle C_n to have a minimal k -equitable labelling? We give a positive answer to this question.

1. Introduction

A *labelling* of the vertices of a graph G is an assignment of distinct natural numbers to the vertices of G . Every labelling induces a natural labelling of the edges: the label of an edge (x, y) is the absolute value of the difference of the labels of x and y . There are many natural questions one can ask about labellings. In particular, Bloom [3] defined a labelling of the vertices of a graph to be *k-equitable* if in the induced labelling of its edges, every label occurs exactly k times, if at all. Furthermore, a *k-equitable* labelling of a graph of order n is said to be *minimal* if the vertices are labelled with $1, 2, \dots, n$. A graph is *minimally k-equitable* if it has a minimal *k-equitable* labelling.

Let us now restrict our attention to cycles. Let C_n be the cycle on n vertices. Given natural numbers n and k , $n \geq 3$, if the cycle C_n is *k-equitable* then obviously k must be a divisor of n . It is also obvious that $k \neq n$. If the stronger assumption that C_n is *minimally k-equitable* holds, then in the appropriate edge-labelling the largest label is at most $n - 1$. Since there are n edges in the cycle C_n , we conclude that $k \neq 1$. Thus a necessary condition for C_n to be *minimally k-equitable* is that k should be a proper divisor of n , i.e. different from 1 and n . Bloom [3] posed the question of whether this necessary condition is also sufficient. In this paper we settle this problem by giving a positive answer to the above question.

The problem of *minimally k-equitable* labellings for cycles is connected with the very difficult conjecture of Ringel and Kotzig concerning decompositions of complete graphs with odd number of vertices into subgraphs isomorphic to trees. This is the main reason why Bloom raised the problem on *k-equitable* labellings of cycles. Let us briefly describe the Ringel-Kotzig conjecture and its connection with labellings.

In 1963 Ringel [7] conjectured that for any natural number n and any $(n + 1)$ -vertex tree T , the complete graph K_{2n+1} could be decomposed into $2n + 1$ subgraphs isomorphic to T . As reported by Rosa [8], Kotzig strengthened Ringel's conjecture as follows. Let $S(K_{2n+1})$ be the set of all subgraphs of K_{2n+1} . Assume that the vertices of K_{2n+1} are the numbers $0, 1, \dots, 2n$, and let the *unit rotation* $R : S(K_{2n+1}) \rightarrow S(K_{2n+1})$ be defined by

$$R[(V(G), E(G))] = \left(\{s(v) : v \in V(G)\}, \{(s(u), s(v)) : (u, v) \in E(G)\} \right),$$

where $s(v) = v + 1 \pmod{2n + 1}$, $0 \leq v \leq 2n$. Assume that we are given a graph G with n edges. Let us say that K_{2n+1} can be *cyclically G -decomposed* if there is a subgraph G' of K_{2n+1} isomorphic to G such that the set $\{G', R(G'), \dots, R^{2n}(G')\}$ is a decomposition of K_{2n+1} , i.e. $E(G') \cup E(R(G')) \cup \dots \cup E(R^{2n}(G'))$ is a partition of $E(K_{2n+1})$. The Ringel-Kotzig conjecture asserts that K_{2n+1} can be cyclically T -decomposed for any tree T with n edges.

For an edge (u, v) of K_{2n+1} , let the reduced label $L(u, v)$ of (u, v) be defined by

$$L(u, v) = \begin{cases} |u - v|, & \text{if } |u - v| \leq n, \\ 2n + 1 - |u - v|, & \text{if } |u - v| > n. \end{cases}$$

Let G' be a subgraph of K_{2n+1} isomorphic to G generating a cyclic G -decomposition of K_{2n+1} . Observe that the reduced labels of the edges of G' are all distinct elements of the set $[1, n] \subset \mathbb{N}$. Rosa [8] defined a labelling of a graph G with n edges to be a ρ -labelling if the vertices of G are assigned n distinct integers from the set $\{0, 1, \dots, 2n\}$ in such a way that for any pair of distinct edges (u, v) and (u', v') of G we have

$$\{|u - v|, 2n + 1 - |u - v|\} \cap \{|u' - v'|, 2n + 1 - |u' - v'|\} = \emptyset.$$

With the above definitions the Ringel-Kotzig conjecture is equivalent to saying that every tree has a ρ -labelling.

Rosa [8] has also defined another class of labellings; these are the β -labellings, more often referred to as graceful labellings. The requirement for a labelling of a graph G with n edges to be graceful is that the vertices of G should be labelled with integers from the set $\{0, 1, \dots, n\}$ in such a way that in the induced edge-labelling the edges of G are labelled with distinct integers. The conjecture that any tree can be labelled gracefully is thus clearly stronger than the Ringel-Kotzig conjecture, and even this is still open. For problems connected with graceful labellings see also [4], [5], [6], [9], [10], [11].

Note that in the case of trees the graceful labellings are essentially the minimal 1-equitable labellings. In the case of cycles these two notions are different. We can easily see that no cycle has a minimal 1-equitable labelling and that the cycle C_n has a graceful labelling if and only if the sum $1 + 2 + \dots + n$ is even, i.e. if and only if $n \equiv 3$ or $0 \pmod{4}$.

We shall now turn to the main problem we are concerned with in this paper. Let us first introduce the terminology we shall use. We shall call a graph G an *integer graph* if its vertex set is a finite subset of \mathbb{N} , and we shall call G a $[p, q]$ -*graph* if p is the smallest vertex of G and q is the largest vertex of G . If such a graph is a cycle, we shall call it an *integer cycle*. If $e = (v_1, v_2)$ is an edge of G , we will say that e has *length* $|v_1 - v_2|$. Let $M = (a_{i,j})$ be an $s \times 2$ matrix with integer entries for which there is a partition $E(G) = E_1 \cup \dots \cup E_s$ such that, for $i = 1, \dots, s$, $a_{i,1}$ is the cardinality of the set E_i and all the edges in E_i have length $a_{i,2}$. Then, we will call M a *distribution of edges* of G .

Let G be a graph, and k a positive integer. Observe that G has a k -equitable labelling if G is isomorphic to an integer graph G' with either 0 or k edges of any length. We will call such G' a *k -equitable representation* of G . Note that G' is a k -equitable representation of a graph if and only if G' has a distribution of edges with the first column having all entries equal to k and the second column having all entries different. Note also that G is minimally k -equitable if there is a k -equitable representation of G which is a $[j, |V(G)| + j - 1]$ -graph for a certain integer j . Then, we shall call G' a *minimal k -equitable representation* of G .

We are going to prove the following theorem.

Theorem 1. *If k and m are integers greater than 1, then the cycle C_{mk} is minimally k -equitable.*

The proof of Theorem 1 will be broken down into several lemmas. Their proofs will contain several constructions of integer cycles. First we shall define the notions needed for these constructions. Let p, q and r be integers such that r is greater than 2 and odd, and $p+r \leq q$. Let $C(p, q; r)$ (see Fig. 1.) be a graph with the vertex set $[p, p+r-1] \cup [q, q+r-1]$, and the edge set

$$\begin{aligned} & \{(p+i, q+i) : i = 0, 1, \dots, r-1\} \cup \{(p+i, p+i+1) : i = 0, 2, 4, \dots, r-3\} \\ & \cup \{(p+r-1, q)\} \cup \{(q+i, q+i+1) : i = 1, 3, 5, \dots, r-2\}. \end{aligned}$$

It follows immediately from the definition that $C(p, q; r)$ is a cycle with the following

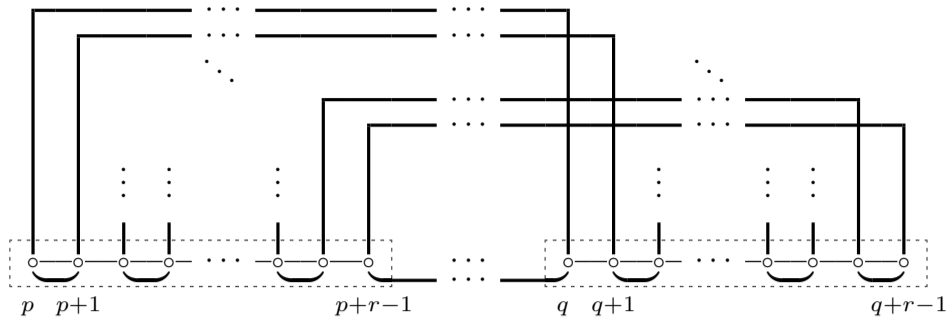

Fig. 1. The graph $C(p, q; r)$.

distribution of edges:

$$\begin{pmatrix} r & q-p \\ r-1 & 1 \\ 1 & q-p-r+1 \end{pmatrix}. \quad (1)$$

Let C be an integer cycle. We will say that C is $(k_1, k_2; t)$ -*outer* if it satisfies the following three conditions.

- (i) $k_1 \geq 0$, $k_2 \geq 0$ and $k_1 + k_2 > 0$,
- (ii) the set V_1 of the k_1 smallest and the set V_2 of the k_2 largest vertices of C are disjoint segments in \mathbb{N} ,
- (iii) every edge of length t has exactly one endvertex in $V_1 \cup V_2$, and every vertex in $V_1 \cup V_2$ is an endvertex of exactly one edge of length t .

Now we shall define a certain operation on outer cycles. Let C be a $(k_1, k_2; t)$ -outer cycle, $V_1 = [p, p+k_1-1]$ be the set of the k_1 smallest vertices of C , and $V_2 = [q-k_2+1, q]$ be the set of the k_2 largest vertices of C . Given a positive integer d , let the $(k_1, k_2; t; d)$ -*extension* C' of C be an integer graph with the vertex set $V(C') = V(C) \cup [p-d-k_2+1, p-d] \cup [q+d, q+d+k_1-1]$ and the edge set defined as follows:

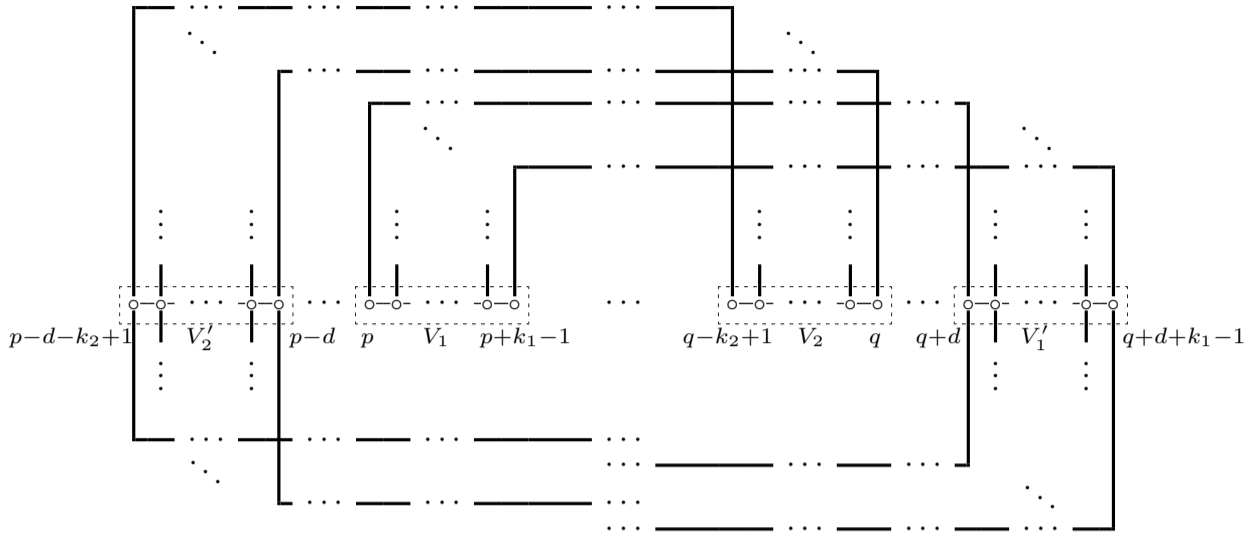

Fig. 2. The operation of taking the $(k_1, k_2; t; d)$ -extension.

$$\begin{aligned}
 E(C') = & E(C) \setminus \{(p+i, p+t+i) : i = 0, \dots, k_1 - 1\} \\
 & \setminus \{(q-i, q-t-i) : i = 0, \dots, k_2 - 1\} \\
 & \cup \{(p+i, q+d+i) : i = 0, \dots, k_1 - 1\} \\
 & \cup \{(p+t+i, q+d+i) : i = 0, \dots, k_1 - 1\} \\
 & \cup \{(q-i, p-d-i) : i = 0, \dots, k_2 - 1\} \\
 & \cup \{(q-t-i, p-d-i) : i = 0, \dots, k_2 - 1\}.
 \end{aligned}$$

What does this apparently complicated construction do? It subdivides every edge of length t with one of the new vertices to get two edges of lengths $q-p+d$ and $q-p-t+d$. The set of new vertices is the union of two segments V_1' and V_2' of cardinalities k_1 and k_2 accordingly. The segment V_1' is placed above the segment $[p, q]$ in the distance d from q , and V_2' is placed below $[p, q]$ in the distance d from p . The vertices from the set V_1' are used to subdivide edges with an endpoint in V_1 and the vertices from the set V_2' are used to subdivide the edges with an endpoint in V_2 (see Fig. 2).

Therefore, assuming that the following matrix is a distribution of edges of C :

$$\begin{pmatrix} a_1 & b_1 \\ a_2 & b_2 \\ \vdots & \vdots \\ a_i & b_i \\ k_1 + k_2 & t \\ a_{i+1} & b_{i+1} \\ a_{i+2} & b_{i+2} \\ \vdots & \vdots \\ a_s & b_s \end{pmatrix},$$

C' has clearly the following distribution of edges:

$$\begin{pmatrix} a_1 & b_1 \\ a_2 & b_2 \\ \vdots & \vdots \\ a_i & b_i \\ k_1 + k_2 & q - p + d \\ k_1 + k_2 & q - p - t + d \\ a_{i+1} & b_{i+1} \\ a_{i+2} & b_{i+2} \\ \vdots & \vdots \\ a_s & b_s \end{pmatrix}. \quad (2)$$

Note that since C is a $[p, q]$ -graph, it does not have edges of length $q - p + d$. Thus, immediately from the definition, we get that C' is a $(k_2, k_1; q - p + d)$ -outer cycle. Also, if C has no edges of length $q - p - t + d$ or if $q - p - t + d = t$, then C' is a $(k_2, k_1; q - p - t + d)$ -outer cycle as well.

To prove Theorem 1, we shall consider the following two cases.

- (i) k is odd,
- (ii) k is even.

Case (i) will be proved in Lemmas 2 and 3 in section 2, and case (ii) will be proved in Lemmas 4 and 5 in section 3.

2. The case k odd

The following lemma takes care of the subcase $m \in [2, 4]$ of case (i).

Lemma 2. *If k is an odd integer greater than 2, and m is 2, 3 or 4, then the cycle C_{mk} is minimally k -equitable.*

Proof. To get a minimal k -equitable representation of C_{2k} , it is enough to take the cycle $C(1, k+1; k)$ which is a $[1, 2k]$ -graph and, by (1), has the following distribution of edges:

$$\begin{pmatrix} k & k \\ k & 1 \end{pmatrix}.$$

Now, let us consider the case $m = 3$. Let C be the $(k, 0; k; 1)$ -extension of $C(1, k+1; k)$. As a result of this operation each edge of length k got subdivided into two edges of lengths $2k$ and k . Indeed, by (2), C is a cycle with the following distribution of edges:

$$\begin{pmatrix} k & 2k \\ k & k \\ k & 1 \end{pmatrix}.$$

C is also clearly a $[1, 3k]$ -graph, and thus a minimal k -equitable representation of C_{3k} . Therefore, to finish the proof of our lemma it remains to settle the case $m = 4$.

Unfortunately, we cannot continue the above construction. We have to start from the beginning with a $[2k+1, 4k]$ -graph $G_1 = C(2k+1, 3k+3; k-2)$ having, by (1), the following distribution of edges:

$$\begin{pmatrix} k-2 & k+2 \\ k-3 & 1 \\ 1 & 5 \end{pmatrix}.$$

Clearly, G_1 is a $(0, k-2; k+2)$ -outer cycle. Let G_2 be the $(0, k-2; k+2; 2)$ -extension of it. This way, each edge of length $k+2$ of G_1 got subdivided into two edges of lengths $2k+1$ and $k-1$ (see (2)). Thus, G_2 is a cycle with the following distribution of edges:

$$\begin{pmatrix} k-2 & 2k+1 \\ k-2 & k-1 \\ k-3 & 1 \\ 1 & 5 \end{pmatrix}.$$

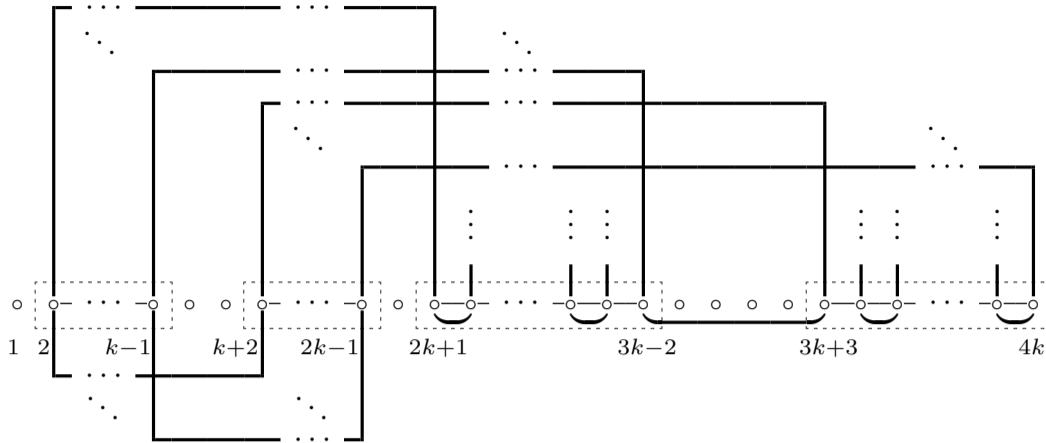

Fig. 3. The graph G_3 .

Let G_3 be obtained from G_2 by adding the segment $S = [2, k - 1]$ to the set of vertices and subdividing each edge of G_2 of length $k - 1$ with an appropriate vertex from S such that the obtained edges have lengths k and $2k - 1$, see Fig. 3.

Thus, G_3 is a cycle and has the following distribution of edges:

$$\begin{pmatrix} k - 2 & 2k + 1 \\ k - 2 & 2k - 1 \\ k - 2 & k \\ k - 3 & 1 \\ 1 & 5 \end{pmatrix}$$

To get a minimal k -equitable representation of C_{4k} we must get rid of the edge of length 5 and create new edges of lengths $2k + 1$, $2k - 1$, k and 1. We have also to remove the gaps from our graph. The graph G_3 is arranged in such a way that both this aims can be easily achieved. Let C be obtained from G_3 by adding the set $\{1, k, k + 1, 2k, 3k - 1, 3k, 3k + 1, 3k + 2\}$ to the set of vertices and subdividing the edge $(3k - 2, 3k + 3)$ with the new

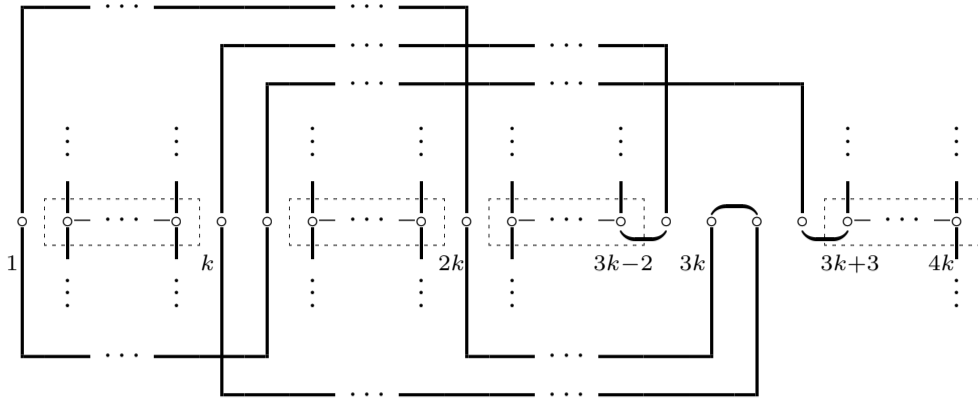

Fig. 4. The subdivision of G_3 .

vertices in such a way that we get the following new edges, see Fig. 4.

$$e_1 = (3k - 2, 3k - 1),$$

$$e_2 = (3k - 1, k),$$

$$e_3 = (k, 3k + 1),$$

$$e_4 = (3k + 1, 3k),$$

$$e_5 = (3k, 2k),$$

$$e_6 = (2k, 1),$$

$$e_7 = (1, k + 1),$$

$$e_8 = (k + 1, 3k + 2),$$

$$e_9 = (3k + 2, 3k + 3).$$

Note that the edges e_3 and e_8 have length $2k + 1$, the edges e_2 and e_6 have length $2k - 1$, the edges e_5 and e_7 have length k and the edges e_1 , e_4 and e_9 have length 1. Thus, the cycle C has the following distribution of edges:

$$\begin{pmatrix} k & 2k + 1 \\ k & 2k - 1 \\ k & k \\ k & 1 \end{pmatrix}.$$

Since C is a $[1, 4k]$ -graph, it is a minimal k -equitable representation of C_{4k} , and so C_{4k} is minimally k -equitable. \square

The next lemma finishes the case k odd.

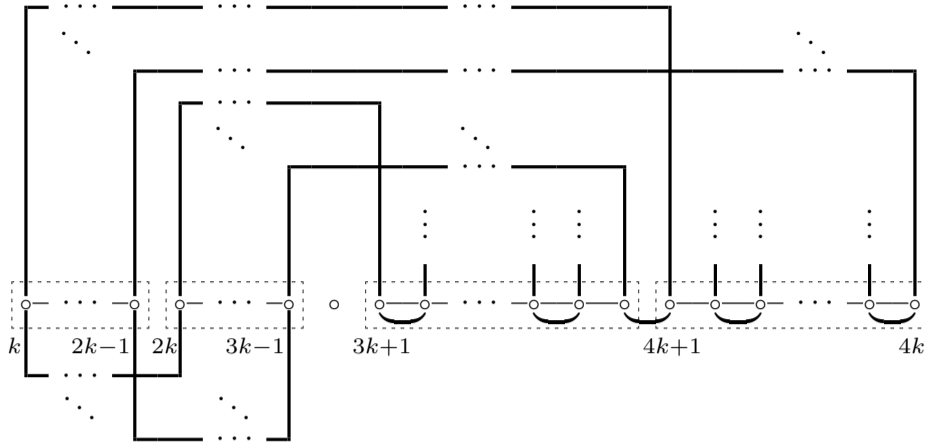

Fig. 5. The graph G_3 .

Lemma 3. *If k is an odd integer greater than 2, and $m > 4$, then the cycle C_{mk} is minimally k -equitable.*

Proof. The construction for $m = 4$ in the proof of Lemma 2 cannot be extended by simple subdivision to give a minimal k -equitable representation of C_{5m} . We must again start from the beginning. Let us start, similarly as for $m = 2, 3$, with $G_1 = C(3k + 1, 4k + 1; k)$ having the following distribution of edges:

$$\begin{pmatrix} k & k \\ k & 1 \end{pmatrix}.$$

Now, let us subdivide the edges of length k , but unlike in the case $k = 3$ in Lemma 2, let us get a graph with a gap of one integer inside it by defining G_2 to be the $(0, k; k; 2)$ -extension of G_1 . G_2 has, thus, the following distribution of edges:

$$\begin{pmatrix} k & 2k + 1 \\ k & k + 1 \\ k & 1 \end{pmatrix},$$

and is a $(0, k; 2k + 1)$ -outer cycle. Continuing with another subdivision, this time of the edges of length $2k + 1$, let G_3 be the $(0, k; 2k + 1; 1)$ -extension of G_2 , see Fig. 5.

Note that the cycle G_3 has the following distribution of edges:

$$\begin{pmatrix} k & 3k + 1 \\ k & k + 1 \\ k & k \\ k & 1 \end{pmatrix}.$$

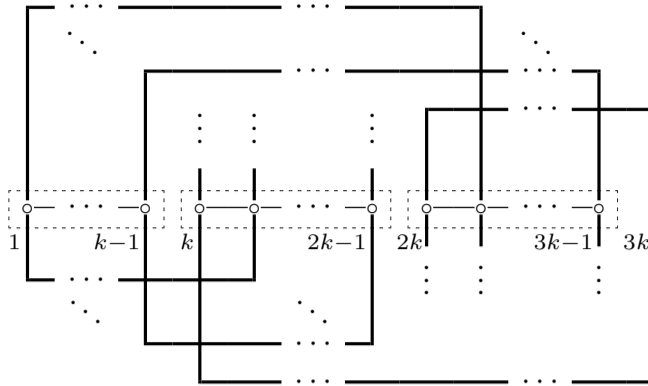

Fig. 6. The subdivision of G_3 .

Now, we shall subdivide the edges of length k in such a way that we remove the gap inside our graph. Let C be obtained from G_4 by adding the set $[1, k-1] \cup \{3k\}$ to the set of vertices, subdividing the edge $(k, 2k)$ with the vertex $3k$ and subdividing every other edge of length k with the appropriate vertex in the segment $[1, k-1]$ such that we get edges of lengths k and $2k$, see Fig. 6.

Thus, the cycle C has the following distribution of edges:

$$\begin{pmatrix} k & 3k+1 \\ k & 2k \\ k & k+1 \\ k & k \\ k & 1 \end{pmatrix}.$$

Since C is a $[1, 5k]$ -graph, it is a minimal k -equitable representation of C_{5k} .

Now, at last, we are at a point from which we can continue by induction. To finish the proof of the lemma, we shall construct by induction a family of cycles $C^{(m)}$, for $m = 5, 6, \dots$, such that $C^{(m)}$ is a minimal k -equitable representation of C_{km} . To keep the induction going, we shall also make sure that the cycle $C^{(m)}$ have the additional property of being $(0, k; (m+1)k/2 + 1)$ -outer for m odd and $(k, 0; (m-2)k/2 - 1)$ -outer for m even.

It will also have the following distribution of edges:

$$\begin{pmatrix} k & 5k \\ k & 6k \\ \vdots & \vdots \\ k & (m-2)k \\ k & (m-1)k \\ k & (m+1)k/2 + 1 \\ k & 2k \\ k & k+1 \\ k & k \\ k & 1 \end{pmatrix}$$

when m is odd and the following:

$$\begin{pmatrix} k & 5k \\ k & 6k \\ \vdots & \vdots \\ k & (m-2)k \\ k & (m-1)k \\ k & (m-2)k/2 - 1 \\ k & 2k \\ k & k+1 \\ k & k \\ k & 1 \end{pmatrix}$$

when m is even.

Let $C^{(5)}$ be the cycle C constructed above. It is clearly a $(0, k; 3k+1)$ -outer cycle with the appropriate distribution of edges. We shall perform the induction by subdividing each edge of $C^{(m)}$ of length $(m+1)k/2 + 1$, for m odd, to get two edges of lengths $mk = ((m+1)-1)k$ and $(m-1)k/2 - 1 = ((m+1)-2)k/2 - 1$. Analogously, for m even, we shall subdivide each edge of $C^{(m)}$ of length $(m-2)k/2 - 1$ to get two edges of lengths mk and $(m+2)k/2 + 1$.

So assume that the cycle $C^{(m)}$ with the required properties is constructed. If m is odd, then $C^{(m)}$ is a $(0, k; (m+1)k/2+1)$ -outer cycle. Let $C^{(m+1)}$ be the $(0, k; (m+1)k/2+1; 1)$ -extension of $C^{(m)}$. Since $C^{(m)}$ does not have edges of length $(m-1)k/2 - 1 = ((m+1)-2)k/2 - 1$, it follows from (2) that $C^{(m+1)}$ is an $(k, 0; ((m+1)-2)k/2 - 1)$ -outer cycle as required. Also by (2), $C^{(m+1)}$ has the required distribution of edges, and is thus a k -equitable representation of $C_{(m+1)k}$. Since the last parameter in the extension operation

by which $C^{(m+1)}$ is defined is equal to 1, $C^{(m+1)}$ is a $[j, j + (m + 1)k - 1]$ -graph for a certain integer j and hence a minimal k -equitable representation of $C_{(m+1)k}$.

If m is even, then $C^{(m)}$ is a $(k, 0; (m - 2)k/2)$ -outer cycle, so let $C^{(m+1)}$ be the $(k, 0; (m - 2)k/2; 1)$ -extension of it. By an argument similar to the above one, $C^{(m+1)}$ has the required properties. \square

3. The case k even

We shall break this case into two cases depending on the divisibility of k by 4. Let us first consider the case $k \equiv 2 \pmod{4}$.

Lemma 4. *If $k \equiv 2 \pmod{4}$ and $m > 1$, then the cycle C_{mk} is minimally k -equitable.*

Proof. Let us assume that k is fixed. We shall prove the lemma by induction on m . Unlike in case (ii), we can start the induction from $m = 2$. Thus, we shall construct a family of cycles $C^{(m)}$, for $m = 2, 3, \dots$, such that $C^{(m)}$ is a minimal k -equitable representation of C_{mk} . The cycle $C^{(m)}$ will have the additional property of being $(k/2, k/2; (m - 1)k/2 + 1)$ -outer for m even and $(k/2, k/2; mk/2 - 1)$ -outer for m odd. It will also have the following distribution of edges:

$$\begin{pmatrix} k & 2k \\ k & 3k \\ \vdots & \vdots \\ k & (m - 2)k \\ k & (m - 1)k \\ k & (m - 1)k/2 + 1 \\ k & 1 \end{pmatrix}$$

when m is even and the following:

$$\begin{pmatrix} k & 2k \\ k & 3k \\ \vdots & \vdots \\ k & (m - 2)k \\ k & (m - 1)k \\ k & mk/2 - 1 \\ k & 1 \end{pmatrix}$$

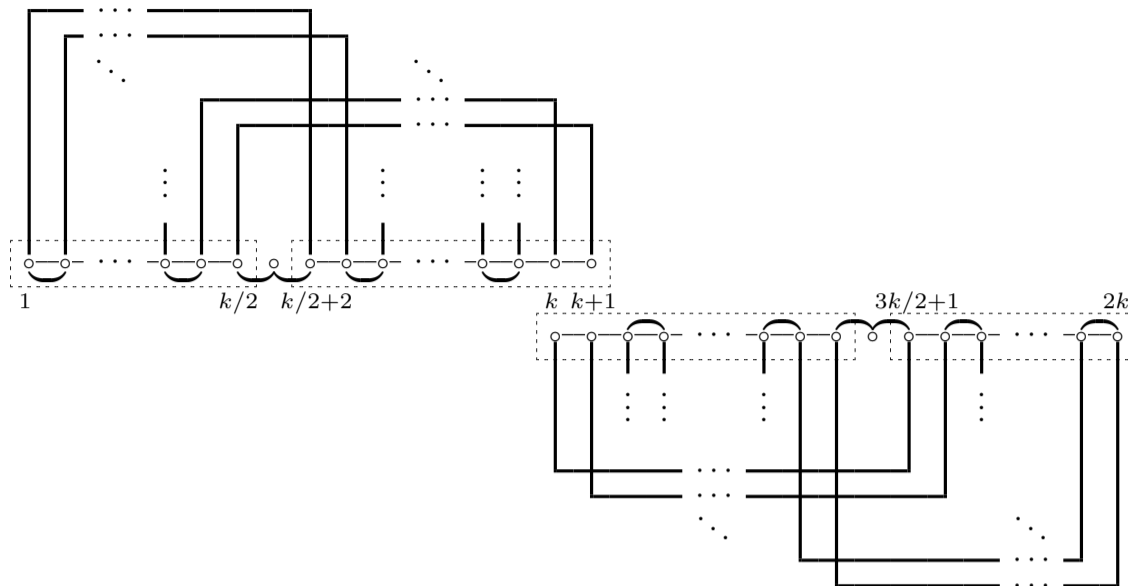

Fig. 7. The cycle $C^{(2)}$.

when m is odd.

The cycle $C^{(2)}$ is constructed as follows. If $k = 2$, then set $C^{(2)} = (1, 2, 4, 3)$. For $k > 2$, let us take two cycles $G_1 = C(1, k/2 + 2; k/2)$ and $G_2 = C(k, 3k/2 + 1; k/2)$. By (1), both G_1 and G_2 have the following distribution of edges:

$$\begin{pmatrix} k/2 & k/2 + 1 \\ k/2 - 1 & 1 \\ 1 & 2 \end{pmatrix}.$$

The cycles G_1 and G_2 have two common vertices k and $k + 1$ and one common edge $e_0 = (k, k + 1)$. Let C be the cycle obtained by taking the union of G_1 and G_2 with the edge e_0 removed. Thus, C has the following distribution of edges:

$$\begin{pmatrix} k & k/2 + 1 \\ k - 4 & 1 \\ 2 & 2 \end{pmatrix}$$

Let $C^{(2)}$ be obtained from C by adding the set $\{k/2 + 1, 3k/2\}$ to the vertex set, and subdividing the edge $(k/2, k/2 + 2)$ with the vertex $k/2 + 1$ and the edge $(3k/2 - 1, 3k/2 + 1)$ with $3k/2$, see Fig. 7.

The cycle $C^{(2)}$ satisfies the required conditions because it is $(k/2, k/2; k/2 + 1)$ -outer, it is a $[1, 2k]$ -graph, and it has the following distribution of edges:

$$\begin{pmatrix} k & k/2 + 1 \\ k & 1 \end{pmatrix}$$

Let us assume that the cycle $C^{(m)}$ is constructed, and that it satisfies the required conditions. In the process of induction, for m even, we shall subdivide each edge of $C^{(m)}$ of length $(m-1)k/2 + 1$ to get two edges of lengths $mk = ((m+1)-1)k$ and $(m+1)k/2 - 1$. Analogously, for m odd, we shall subdivide each edge of $C^{(m)}$ of length $mk/2 - 1$ to get two edges of lengths mk and $mk/2 + 1 = ((m+1)-1)k/2 + 1$.

If m is even, then $C^{(m)}$ is a $(k/2, k/2; (m-1)k/2 + 1)$ -outer cycle. Let $C^{(m+1)}$ be the $(k/2, k/2; (m-1)k/2 + 1; 1)$ -extension of it. Since if $(m+1)k/2 - 1 \neq (m-1)k/2 + 1$, then $C^{(m)}$ does not have edges of length $(m+1)k/2 - 1$, $C^{(m+1)}$ is a $(k/2, k/2; (m+1)k/2 - 1)$ -outer cycle by (2). It also follows from (2) that $C^{(m+1)}$ has the required distribution of edges and hence it is a k -equitable representation of $C_{(m+1)k}$. $C^{(m+1)}$ is also clearly a $[j, j + (m+1)k - 1]$ -graph for certain integer j , and so a minimal k -equitable representation of $C_{(m+1)k}$.

If m is odd, then let $C^{(m+1)}$ be the $(k/2, k/2; mk/2 - 1)$ -extension of $C^{(m)}$. Similarly as above, it can be verified that all the required conditions are satisfied. \square

Now we shall consider the case $k \equiv 0 \pmod{4}$.

Lemma 5. *If $k \equiv 0 \pmod{4}$ and $m > 1$, then the cycle C_{mk} is minimally k -equitable.*

Proof. Let us assume that k is fixed. Similarly as in the proof of Lemma 4, we shall use induction on m , and we shall construct a family of cycles $C^{(m)}$, for $m = 2, 3, \dots$, such that $C^{(m)}$ is a minimal k -equitable representation of C_{mk} . Now, the cycle $C^{(m)}$ will have the additional property of being $(k_1, k_2; (m-1)k/2 + 1)$ -outer for m even and $(k_2, k_1; mk/2 - 1)$ -outer for m odd, where $k_1 = k/2 + 1$ and $k_2 = k/2 - 1$. As in the construction used to

prove Lemma 4, it will have the following distribution of edges:

$$\begin{pmatrix} k & 2k \\ k & 3k \\ \vdots & \vdots \\ k & (m-2)k \\ k & (m-1)k \\ k & (m-1)k/2 + 1 \\ k & 1 \end{pmatrix}$$

when m is even and the following:

$$\begin{pmatrix} k & 2k \\ k & 3k \\ \vdots & \vdots \\ k & (m-2)k \\ k & (m-1)k \\ k & mk/2 - 1 \\ k & 1 \end{pmatrix}$$

when m is odd.

The cycle $C^{(2)}$ is constructed in a way which is a slight modification of the method used to prove lemma 4. Let $G_1 = C(1, k/2 + 2; k_1)$ and $G_2 = C(k + 1, 3k/2 + 2; k_2)$. Note that k_1 and k_2 are odd integers. By (1), G_1 has the following distribution of edges:

$$\begin{pmatrix} k/2 + 1 & k/2 + 1 \\ k/2 + 1 & 1 \end{pmatrix},$$

and G_2 the following:

$$\begin{pmatrix} k/2 - 1 & k/2 + 1 \\ k/2 - 2 & 1 \\ 1 & 3 \end{pmatrix}.$$

The cycles G_1 and G_2 have two common vertices $k + 1$ and $k + 2$ and one common edge $e_0 = (k + 1, k + 2)$. Let C be the cycle obtained by taking the union of G_1 and G_2 with the edge e_0 removed. Thus, C has the following distribution of edges:

$$\begin{pmatrix} k & k/2 + 1 \\ k - 3 & 1 \\ 1 & 3 \end{pmatrix}$$

Let $C^{(2)}$ be obtained from C by adding the set $\{3k/2, 3k/2 + 1\}$ to the vertex set, and subdividing the edge $(3k/2 - 1, 3k/2 + 2)$ with the vertices $3k/2$ and $3k/2 + 1$ as to get three edges of length 1, see Fig. 8.

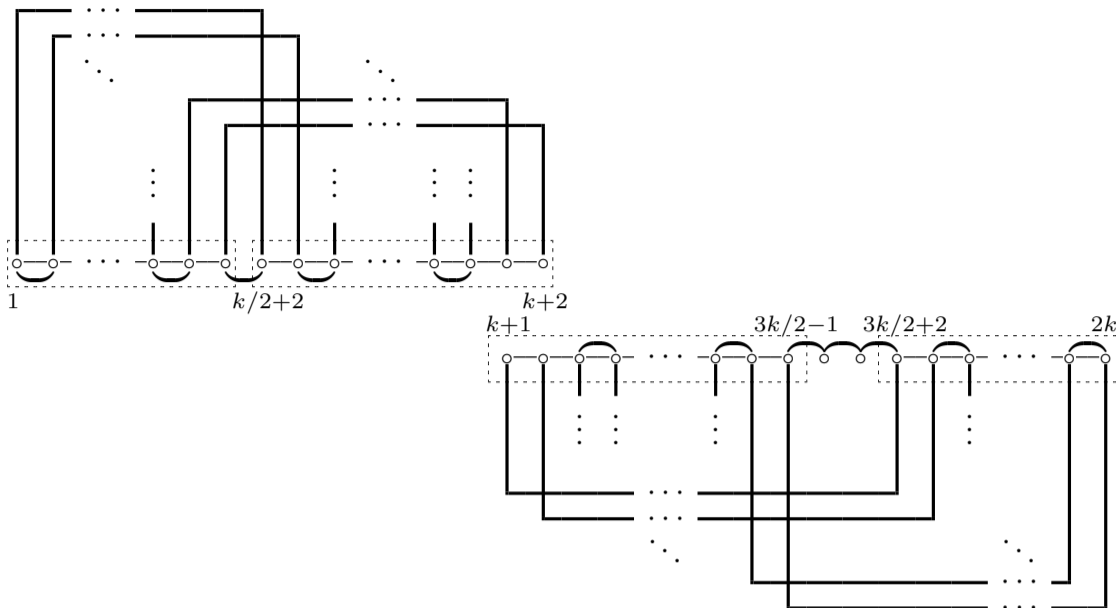

Fig. 8. The cycle $C^{(2)}$.

Hence, the cycle $C^{(2)}$ satisfies the required conditions because it is $(k_1, k_2; k/2 + 1)$ -outer, it is a $[1, 2k]$ -graph, and it has the following distribution of edges:

$$\begin{pmatrix} k & k/2 + 1 \\ k & 1 \end{pmatrix}$$

Let us assume that the cycle $C^{(m)}$ is constructed and that it satisfies the required conditions. The induction goes almost exactly as in the proof of Lemma 4. The only difference is that the endpoints of the edges to be subdivided do not lie symmetrically at both ends of the segment of all vertices, but there are k_1 of them at one end and k_2 of them at the other.

If m is even, then $C^{(m)}$ is a $(k_1, k_2; (m-1)k/2 + 1)$ -outer cycle thus let $C^{(m+1)}$ be the $(k_1, k_2; (m-1)k/2 + 1; 1)$ -extension of it. If m is odd, then $C^{(m)}$ is $(k_2, k_1; mk/2 - 1)$ -outer so let $C^{(m+1)}$ be obtained by taking the $(k_2, k_1; mk/2 - 1)$ -extension of it. Similarly as in the proof of Lemma 4, it can be shown that all the required conditions are satisfied. \square

Remark. The author has been informed recently that Theorem 1 has been proved independently by G. Bloom.

Acknowledgements. This work is a part of the author's Ph.D. thesis [12] written at the University of Cambridge under the direction of Dr. Béla Bollobás. I would like to thank him for drawing my attention to the problem studied in this note and for his continued help and encouragement.

References

- [1] BHATT, S.N., LEIGHTON, F.T., A framework for solving VLSI graph layout problems, *J. Comp. System Sci.* **28** (1984), 300–343.
- [2] BHATT, S.N., LEISERSON, C.E., How to assemble tree machines, in “Proc. 14th Symp. on the Theory of Computing”, San Francisco 1981, pp. 99–104.
- [3] BLOOM, G., Problem posed at the Graph Theory meeting of the New York Academy of Sciences, November 1989.
- [4] DUKE, R.A., Can the complete graph with $2n + 1$ vertices be packed with copies of an arbitrary tree having n edges?, *Am. Math. Mon.* **76** (1969), 1128–1130.
- [5] GOLOMB, S.W., How to number a graph, in *Graph Theory and Computing*, R.C. Read, Ed. Academic Press, New York, N.Y. 1972, pp. 23–37.
- [6] KOTZIG, A., On certain vertex-valuations of finite graphs, *Utilitas Math.* **4** (1973), 261–290.
- [7] RINGEL, G., Problem 25, *Theory of Graphs and Its Applications*, Proc. Int. Symp. Smolenice (June 1963), Czech Acad. Sci. Prague, Czech. 1964, p. 162.
- [8] ROSA, A., On certain valuations of the vertices of a graph, *Theory of Graphs*, Gordon and Breach, New York, N.Y. 1967, pp. 349–355.
- [9] ROSA, A., Labeling snakes, *Ars Combinatoria* **3** (1977), 67–74.
- [10] SHEPPARD, D.A., The factorial representation of balanced labeled graphs, *Discrete Math.* **15** (1976), 379–388.
- [11] STANTON, R.G., ZARNKE, C.R., Labelling of balanced trees, Proc. Fourth S. E. Conf. Combinatorics Graph Theory Comp. Utilitas Math., Winnipeg, Manitoba, Canada 1973, pp. 479–495.
- [12] WOJCIECHOWSKI, J., Long Induced Cycles in the Hypercube and Colourings of Graphs, Ph.D. thesis, Cambridge University, England (April 1990).